



Poly Studio G62 User Guide

SUMMARY

This guide provides the end-user with task-based user information for the named product.

Legal information

Copyright and license

© 2024, HP Development Company, L.P. The information contained herein is subject to change without notice. The only warranties for HP products and services are set forth in the express warranty statements accompanying such products and services. Nothing herein should be construed as constituting an additional warranty. HP shall not be liable for technical or editorial errors or omissions contained herein.

Trademark credits

All third-party trademarks are the property of their respective owners. g

Privacy policy

HP complies with applicable data privacy and protection laws and regulations. HP products and services process customer data in a manner consistent with the HP Privacy Policy. Please refer to [HP Privacy Statement](#).

Open source software used in this product

This product contains open source software. You may receive the open source software from HP up to three (3) years after the distribution date of the applicable product or software at a charge not greater than the cost to HP of shipping or distributing the software to you. To receive software information, as well as the open source software code used in this product, contact HP by email at ipgoopensourceinfo@hp.com.

Table of contents

1 About this guide	1
Audience, purpose, and required skills	1
Icons used in Poly documentation	1
2 Getting Started	2
Poly Studio G62 product overview	2
Poly Studio G62 system ports	2
Poly Studio G62 LED behavior	3
Powering the System On and Off	4
Power on your Poly Studio G62 system	4
Connecting IP peripherals to the Poly Studio G62 LLN port	5
Accessibility Features	6
Users Who Are Deaf or Hard of Hearing	6
Users Who Are Blind, Have Low Vision, or Have Limited Vision	6
Users with Limited Mobility	7
3 Hardware installation	8
Mounting your Poly Studio G62 system	8
Required airflow clearance for a Poly Studio G62 system	8
Connect monitors to the Poly Studio G62 system	9
Pair a Poly TC10 or Poly TC8 to your Poly Studio G62 system	9
Connect IP microphones to the Poly Studio G62 system	10
Connect a USB camera to the Poly Studio G62 system	10
Connect a Poly Studio E70 as an IP camera to the Poly Studio G62 system	11
Connect a 3.5mm audio output device to the Poly Studio G62 system	11
Connect a USB audio DSP to your Poly Studio G62 system	12
Pairing a Poly Trio C60 speakerphone to a Poly Studio G62	12
4 Setting up the Poly Studio G62 system	14
Complete the out of box setup and choose a provider	14
5 Using the Poly Studio G62 system	16
Configuring your Poly Studio G62 system	16

Access the System Web Interface	16
Navigating the Poly Studio G62 system interface	16
Using Device Mode	17
Updating your Poly Studio G62 system	17
Updating Software in the System Web Interface	18
Automatically Update Software.....	18
Manually Update Software.....	19
Update your system using a USB flash drive.....	19
Registering the System with Poly Lens.....	19
Factory Restore the Poly Studio G62.....	19
Locate the System IP Address Using the System Monitor and a USB Mouse	20
Locate the System IP Address Using a Paired TC8 or TC10 Touch Controller.....	20
Locate the System Serial Number	21
Locate the Serial Number On Your Poly Studio G62	21
6 Getting help	22
HP Inc. addresses.....	22
Document information	22

1 About this guide

This guide describes how to use the Poly Studio G62 system.

Audience, purpose, and required skills

This guide is intended for beginning users, as well as intermediate and advanced users, who want to learn more about the features available with the Poly Studio G62 system.

Icons used in Poly documentation

This section describes the icons used in Poly Documentation and what they mean.

 **IMPORTANT:** Indicates information considered important but not hazard-related (for example, messages related to property damage). Warns the user that failure to follow a procedure exactly as described could result in loss of data or in damage to hardware or software. Also contains essential information to explain a concept or to complete a task.

 **NOTE:** Contains additional information to emphasize or supplement important points of the main text.

2 Getting Started

Poly Studio G62 enables you to set up a medium to large-size video conferencing room with flexibility and options depending on the number of occupants and type of conference room.

Poly Studio G62 supports Poly Video mode and multiple partner application modes. For supported partner applications, see the *Poly VideoOS Release Notes*.

Poly Studio G62 product overview

The Poly Studio G62 system is an Android-based codec with HDMI, IP LLN, and USB connections to support custom conference rooms.

Designed with simplified mounting and PoE+ power, Poly Studio G62 can be placed behind a display, under a table, or in an AV rack. The Poly Studio G62 system supports Poly audio and video products over IP LLN as well as Poly and third-party products over USB.

The Poly Studio G62 system brings the following functionality to your conferencing space:

- Audio innovations such as NoiseBlock AI
- DirectorAI camera framing and tracking
- Configurable second network port for accessories
- Dual monitor 4K video
- Flexible installation with cable management
- USB-C DP Alt Mode port for content and device mode
- Wireless content sharing using Airplay or Miracast

Poly Studio G62 system ports

The following diagram describes the ports available on a Poly Studio G62 system.

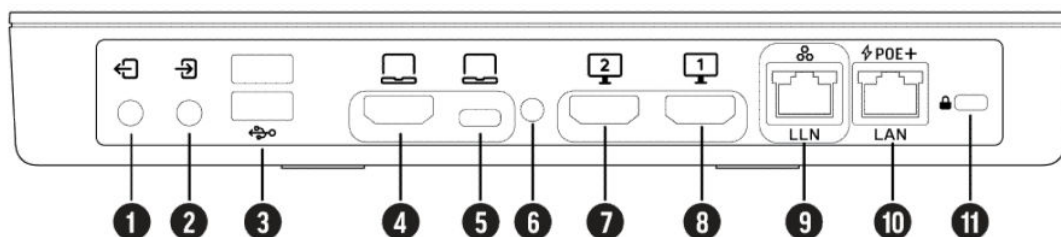

Table 2-1 Poly Studio G62 Ports

Item	Port	Description
1	3.5 mm output	Connects speakers to the system.
2	3.5 mm input	Connects microphones to the system.
3	USB Type-A ports (3.0)	Connects USB cameras or USB audio DSPs.
4	HDMI input	Provides the following options: <ul style="list-style-type: none">• Connects an HDMI content source or HDMI camera.• Use the system monitor when connected to a computer HDMI port. Provides content sharing capabilities.
5	USB Type-C port	Provides the following options: <ul style="list-style-type: none">• Use the system camera, speaker, and microphone from a connected laptop.• Use the system camera, speaker, microphone, and monitor using a DP Alt-mode connection. Requires a supported DP Alt-mode cable and a computer with a USB Type-C port that supports DP Alt-mode.
6	Pinhole reset	Factory resets the system.
7	HDMI 2	Connects a secondary monitor.
8	HDMI 1	Connects a primary monitor.
9	LLN port	Connects IP peripherals such as a Poly IP microphone or Poly IP camera. This port doesn't provide power. A PoE switch or PoE injector is required to power IP peripherals connected to the LLN port.
10	PoE+ power input	Powers the Poly Studio G62 system using a class 4 PoE+ injector or PoE+ switch. Provides access to the corporate network.
11	Security lock	Physically secures the system.

Poly Studio G62 LED behavior

Use the LED on the front left corner of the Poly Studio G62 system to get information on the state of your system.

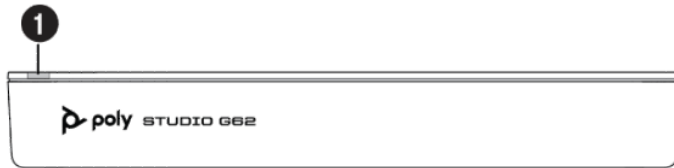

Table 2-2 Poly Studio G62 LED Behavior

Indicator	Status
Blinking white	Powering on
Solid white	Powered on
Solid green	In a call
Blinking amber	Update in progress
Solid amber	Sleeping
Blinking red	Error preventing normal operations
Solid red	Muted microphone

Powering the System On and Off

The system powers on when you plug it in to a power source.

Poly recommends the following when powering off or restarting your system:

- Don't restart or power off the system during maintenance activities (for example, while a software update is in progress).
- If a system restart is necessary, use the system web interface, RestAPI, Telnet, or SSH. If possible, avoid removing power to restart the system.

Power on your Poly Studio G62 system

You can use a PoE+ class 4 injector or a PoE+ class 4 Ethernet connection to power your system.

The Poly Studio G62 system doesn't include a power button. The system powers on when connected to a PoE+ class 4 injector or Ethernet switch. If your PoE connection doesn't provide sufficient power, the following message displays on the monitor:

"Insufficient Power from System Ethernet Port"

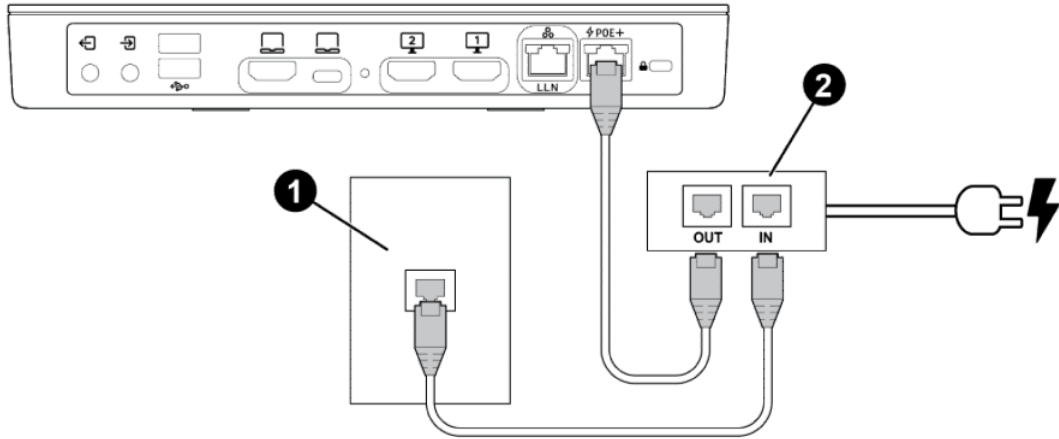

Table 2-3 Components for powering on a Poly Studio G62

Item	Description
1	Ethernet connection to the corporate network.
2	PoE+ class 4 power injector.

1. Connect the PoE+ LAN port on the Poly Studio G62 system to the Out port on the PoE+ power injector.
2. Connect the In port on the PoE+ power injector to a network Ethernet port.

Alternatively, you can connect the Poly Studio G62 system directly to a network Ethernet port providing PoE+ class 4 power.

Connecting IP peripherals to the Poly Studio G62 LLN port

Connect Poly IP microphones and Poly IP cameras to your Poly Studio G62 system LLN port.

 **NOTE:** For supported peripherals and configurations, see the *Poly VideoOS Release Notes*.

When connecting IP devices to the Poly Studio G62 system LLN port, observe the following:

- The Poly Studio G62 system LLN port provides a secure connection for audio and video IP devices such as Poly IP microphones and a Poly Studio E70 camera.

The Poly Studio G62 system LLN port doesn't provide power to connected peripherals.

- To power IP peripherals connected to the Poly Studio G62 system LLN port, use an A/V Ethernet switch such as a Netgear A/V Line M4250 GSM4210PD.
- The LLN port doesn't provide network access.

Don't connect IP devices to the LLN port that need an internet connection such as a Poly TC10, Poly TC8, or Poly Trio C60.

- To connect IP cameras, use a CAT5e, CAT6, or CAT7 direct STP Ethernet cable. The cable can be up to 91 m (300 ft) in length.

Accessibility Features

Poly products include a number of features to accommodate users with disabilities.

 **NOTE:** Accessibility features for Poly Studio G62 include peripherals required for system functionality included connected cameras, microphones, speakers, and monitors.

Users Who Are Deaf or Hard of Hearing

Your system includes accessibility features so that users who are deaf or hard of hearing can use the system.

The following table lists the accessibility features for users who are deaf or hard of hearing.

Table 2-4 Accessibility Features for Users Who Are Deaf or Hard of Hearing

Accessibility Feature	Description
Visual notifications	Status and icon indicators let you know when you have incoming, outgoing, active, or held calls. Indicators also alert you of the device's status and when features are enabled.
Status indicator lights	The system and its microphones use LEDs to indicate some statuses, including if your microphones are muted. The system and its connected cameras and microphones use LEDs to indicate some statuses, including if your microphones are muted.
Adjustable call volume	While in a call, you can raise or lower the volume of the device.
Auto-answering	You can enable the system to auto-answer calls.

Users Who Are Blind, Have Low Vision, or Have Limited Vision

Your system includes accessibility features so that users who are blind, have low vision, or have limited vision can use the system.

The following table lists the accessibility features for users who are blind, have low vision, or have limited vision.

Table 2-5 Accessibility Features for Users Who Are Blind, Have Low Vision, or Have Limited Vision

Accessibility Feature	Description
Auto-answering	You can enable the system to auto-answer calls.
Mute auto-answered calls	You can configure the system to mute auto-answered calls.
Ringtones	An audible tone plays for incoming calls.
Adjustable backlight settings	You can change the brightness of the screen by adjusting backlight intensity settings.
Visual notifications	Status and icon indicators let you know when you have incoming, outgoing, active, or held calls. Indicators also alert you of the device's status and when features are enabled.
Join and leave tones	The system plays a tone when someone joins or leaves a conference call.
Embossed buttons	The remote control has embossed push buttons for performing common tasks with the system, such as dialing a number.

Users with Limited Mobility

Your system includes accessibility features so that users with limited mobility can use various system features.

The following table lists the accessibility features for users with limited mobility.

Table 2-6 Accessibility Features for Users with Limited Mobility

Accessibility Feature	Description
Remote control	The Bluetooth remote control enables you to control the system and to perform tasks such as placing calls, starting a sharing session, and configuring some settings.
Alternative control interface	This product provides an alternative control interface for the connected video conferencing system for people with disabilities that cause limited manipulation issues.
Poly TC10 or Poly TC8	The Poly TC10 or Poly TC8 enables you to control the system and to perform tasks such as placing calls.
Auto-answering	You can enable the system to auto-answer calls.
Calling from a personal device	With administrator credentials, you can wirelessly access the system web interface from your own device to make calls and manage contacts and favorites.
Touch-capable monitor support	If you have a touch-capable monitor connected to the system, you can select, swipe, and press the screen to perform functions and activate features.
Flexible mounting/display configurations	Product isn't stationary and can be mounted or displayed in various configurations. Touch controls require minimal strength to operate.

3 Hardware installation

Mount your Poly Studio G62 system and connect peripherals such as a monitor, camera, microphone, and speaker.



NOTE: For supported peripherals and configurations, see the *Poly VideoOS Release Notes*.

To ensure full functionality, the Poly Studio G62 system requires that you connect the following peripherals:

- Camera
- Microphone
- Speaker
- Monitor
- Controller

Your peripherals and configuration depend on the room size and room type.

For more information on connecting components and configuring the Poly Studio G62 system, see the *Poly Video Mode Administrator Guide* and the *Poly Partner Mode Administrator Guide* at <https://www.docs.poly.com>.

Mounting your Poly Studio G62 system

You can mount the Poly Studio G62 using the supplied magnetic feet or the optional magnetic plate.

For information on mounting your Poly Studio G62 system, see the *Poly Studio G62 Mounting Plate and PoE Quick Start Guide*.

Required airflow clearance for a Poly Studio G62 system

When installing your Poly Studio G62 system, provide adequate space for airflow..



CAUTION: To avoid thermal issues with your Poly Studio G62 system, ensure that there is proper spacing away from the vent holes.

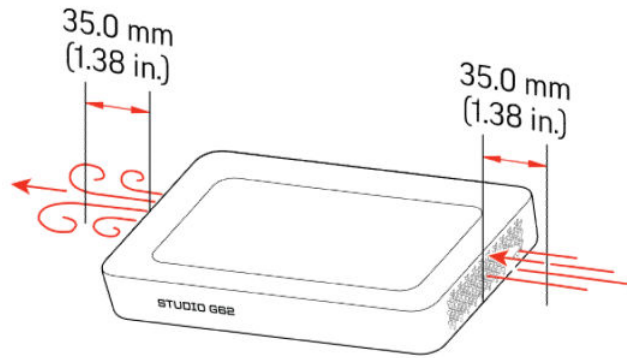

Connect monitors to the Poly Studio G62 system

Connect two monitors to the system to display far-side video and content.

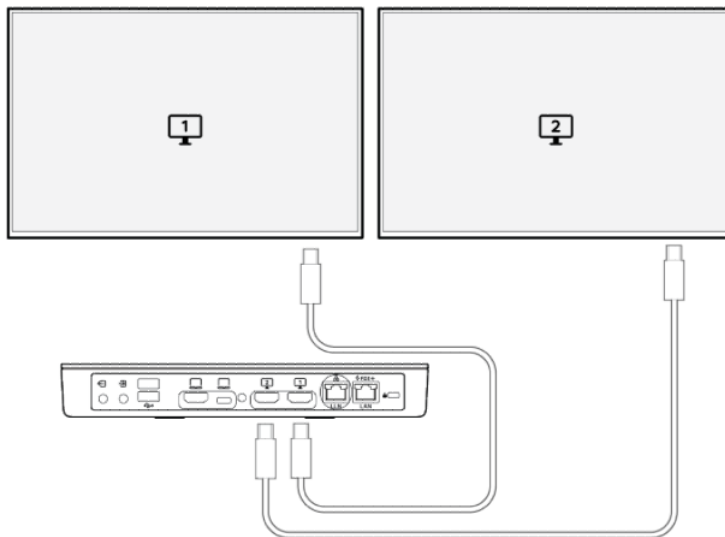

1. Connect one end of the HDMI cable to HDMI port 1 on the primary monitor.
2. Connect the other end of the HDMI cable to the HDMI 1 port on the Poly Studio G62 system.
3. Connect a second monitor to the HDMI 2 port on the Poly Studio G62 system.

Pair a Poly TC10 or Poly TC8 to your Poly Studio G62 system

You can pair one or more Poly TC10 or Poly TC8 to your Poly Studio G62 system.

1. Connect the Poly TC10 or Poly TC8 to a PoE Ethernet connection connected to your network.

You can't connect the Poly TC10 or Poly TC8 to an Ethernet switch connected to the Poly Studio G62 system LLN port.

2. At startup, use the out of box setup wizard to pair the Poly TC10 or Poly TC8 to your Poly Studio G62 system.

If you're setting up a new system, you can use the Poly TC10 or Poly TC8 to out of box the touch controller and the system at the same time.

Connect IP microphones to the Poly Studio G62 system

Connect up to three Poly IP microphones to the Poly Studio G62 system.

 **NOTE:** The Poly Studio G62 system LLN port doesn't provide power to connected peripherals. Use a PoE Ethernet switch or PoE injector to power your Poly IP peripherals.

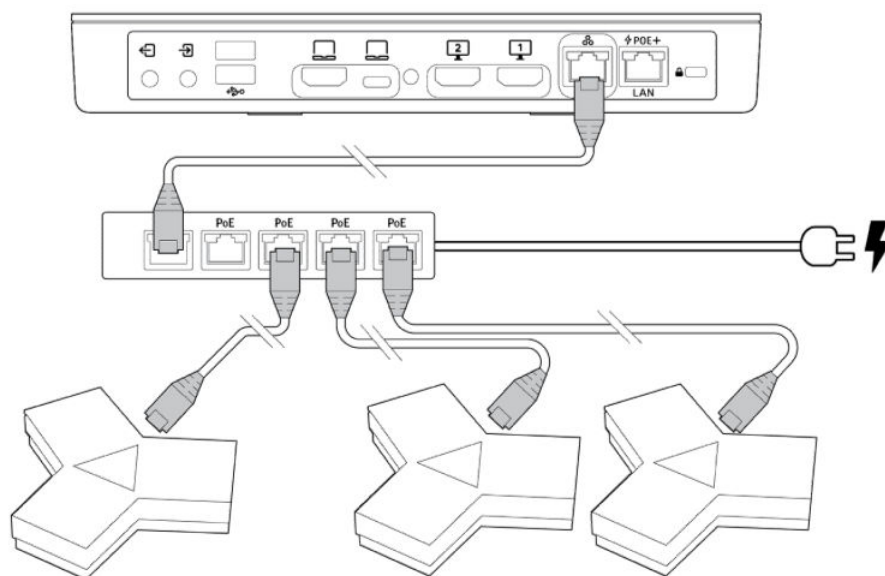

1. To provide power for your Poly IP microphones, connect a PoE Ethernet switch to the LLN port on the Poly Studio G62 system.

If you're connecting only one Poly IP microphone, you can use a PoE injector.

2. Using the cables supplied with your Poly IP microphones, connect the microphones to the Ethernet switch.

Alternatively, you can connect the microphones using a CAT5e, CAT6, or CAT7 direct STP Ethernet cable. The cable can be up to 91 m (300 ft) in length.

3. After powering on your system, finish setup by accessing the system web interface.
 - a. In the system web interface, go to **Device Management > Available Devices**.
 - b. Next to the Poly IP microphone entry, select **Pair**.

Connect a USB camera to the Poly Studio G62 system

Connect a supported or compatible USB camera to your Poly Studio G62 system.

 **NOTE:** Power off the system before connecting or disconnecting USB cameras.

 **NOTE:** If you connect a third-party camera to the system, camera controls may be limited or unavailable. Poly DirectorAI features such as camera tracking and DirectorAI Perimeter aren't available.

- Using the USB cable that shipped with your camera, connect the camera to an available USB-A port on the Poly Studio G62 system.

When the Poly Studio G62 system starts, the camera displays in the system web interface under **General Settings > Device Management** under **Connected Devices**.

Connect a Poly Studio E70 as an IP camera to the Poly Studio G62 system

Connect a supported Poly IP camera to your Poly Studio G62 system.

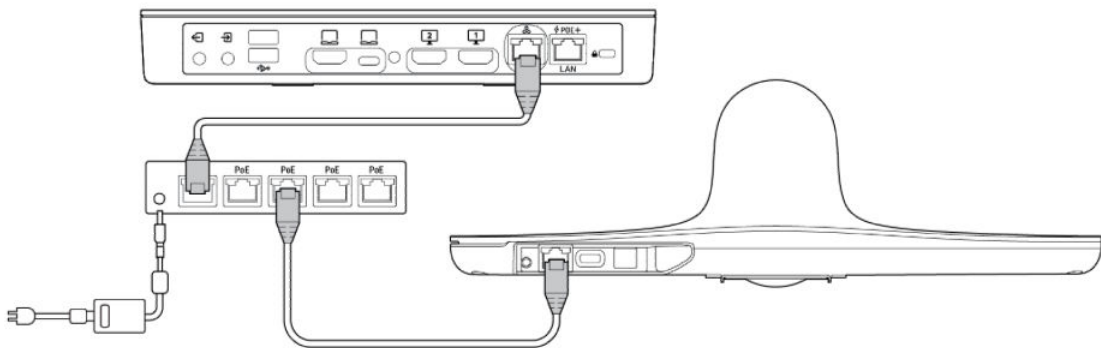

 **NOTE:** The Poly Studio G62 system LLN port doesn't provide power to connected peripherals. Use a PoE Ethernet switch or PoE injector to power your Poly IP peripherals.

1. To provide power and data connectivity, connect a PoE Ethernet switch to the LLN port on the Poly Studio G62 system.
If you're connecting only one Poly IP camera, you can use a PoE injector.
2. Using the Ethernet cable that shipped with your camera, connect the camera to an available port on the Ethernet switch.
3. After powering on your system, finish setup by accessing the system web interface.
 - a. In the system web interface, go to **Device Management > Available Devices**.
 - b. Next to the Poly IP camera entry, select **Pair**.

Connect a 3.5mm audio output device to the Poly Studio G62 system

Connect an audio output device such as an amplifier or sound bar to your system using the 3.5mm audio output port.

External amplifiers may have other settings that must be changed. Third-party amplifiers and speakers should be tuned for proper operation per manufacturer guidelines and audio industry standards.

If your audio device has an option for fixed or variable audio, choose variable to allow audio output adjustment from the system controller.

1. Connect the speaker to the 3.5mm output port on the system.
Make sure the 3.5mm connector is fully seated in the connector.
2. In the system web interface, go to **Audio/Video > Audio > Line Out**.
3. Select **Variable**.
4. From the **Speaker Options** drop down menu, choose **Line Out**.
5. Go to **Audio/Video > Audio > General Audio Settings**.
6. Verify that **Transmission Audio Gain (dB)** is set to 0dB.

Connect a USB audio DSP to your Poly Studio G62 system

Connect a supported audio DSP to your system to handle audio input and output.

1. Connect a USB cable from the audio DSP to a USB Type-A connection on the system.
2. In the system web interface, go to **Audio / Video > Audio** and enable the **Enable USB Audio** check box.

The system saves your changes automatically.

Pairing a Poly Trio C60 speakerphone to a Poly Studio G62

You can use a Poly Trio C60 speakerphone as a controller and audio device with a Poly Studio G62 system.

See your system's latest *Poly VideoOS Release Notes* for supported Poly Trio models.

You can connect up to four Poly Trio C60 speakerphones to your system for use as an audio device.



NOTE: You can't use a Poly Trio C60 speakerphone if your system is connected to Wi-Fi as the primary network.

In Poly Video mode and Poly Device Mode, you can connect up to four Poly Trio C60 speakerphones to your system for use as an audio device.

This setup is supported while using the following third-party conferencing applications:

- Zoom Rooms - Speaker, microphone, and Zoom Rooms controller. You can connect up to four Poly Trio C60 speakerphones. Each Poly Trio C60 speakerphone connected to the system counts against the total of five controllers supported in Zoom Rooms mode.
- Microsoft Teams Rooms - Speaker and microphone only. You can connect one Poly Trio C60 speakerphone to your system.

The Microsoft Teams Rooms controller on the Poly Trio C60 speakerphone offers limited functionality and is not supported as a Teams Rooms controller. Use a connected Poly TC8 and Poly TC10 touch controller or touch screen monitor to control your Microsoft Teams Rooms environment.

For information on pairing a Poly Trio C60 speakerphone to your system, see the *Poly Video Mode Administrator Guide* or the *Poly Partner Mode Administrator Guide* at <https://www.docs.poly.com>.

4 Setting up the Poly Studio G62 system

After connecting the peripherals, you can power on and set up your system.

You can set up the system using one of the following methods:

- Using the out of box setup on a Poly TC10 or Poly TC8 touch controller
The Poly TC10 or Poly TC8 must be on version 6.0 or later and connected to the same subnet as the Poly Studio G62 system.
- Accessing the system web interface
- Onboarding the system to Lens Cloud

Complete the out of box setup and choose a provider

After connecting peripherals, power on the Poly Studio G62 system and complete the out of box set up on a connected Poly TC10 or Poly TC8.

 **IMPORTANT:** Poly strongly recommends that you update your system to the latest Poly VideoOS version. Updating your system ensures that you have access to the latest Poly Studio G62 system features and functionality.

1. Connect the Poly TC10 to a PoE-enabled Ethernet port on the same subnet as the Poly Studio G62 system.
The Poly TC10 powers on and displays the out of box screen.
2. Connect the Poly Studio G62 system to a PoE+ Class 4 Ethernet port on the same subnet as the Poly TC10.
The system powers on and displays the *Connect a Controller* screen including the system IP address and the serial number.
3. On the Poly TC10, select **Get Started**.
4. Review the network and regional details, then select the right arrow.
5. Select **Room Controller** and select the right arrow.

The Poly TC10 searches for the Poly Studio G62 system in the out of box state and displays the results.

6. Use the system IP address to select your Poly Studio G62 system from the results and select the right arrow.

Alternatively, select **Manually Connect to a Room** and enter the Poly Studio G62 system IP address.

7. If the room requires further authentication, the Poly Studio G62 system display shows a collection of shapes. Select the sequence of shapes on the Poly TC10 that matches the sequence of shapes on the Poly Studio G62 system display and select **Confirm**.
8. Depending on the Poly Studio G62 system configuration, the Poly TC10 displays some of the following screens.
 - Poly Lens registration
 - Provider selection
 - Option to update software if a software update is available

The Poly TC10 and the Poly Studio G62 system restart into the chosen partner application.

5 Using the Poly Studio G62 system

After connecting peripherals and powering on your Poly Studio G62 system, you can begin using the system with your chosen conferencing provider.

Configuring your Poly Studio G62 system

You can configure your Poly Studio G62 system using multiple options.

To configure the system and change settings, use one of the following options:

- Access the system web interface
- Onboard your system to Poly Lens Cloud
- Onboard your system to Poly Clariti
- Use CLI or REST APIs

For advanced configuration information including network setup and security settings, see the *Poly Video Mode Administrator Guide* and the *Poly Partner Mode Administrator Guide*.

Access the System Web Interface

Access the system web interface to perform administrative tasks.

 **IMPORTANT:** If not prompted to do so during setup, Poly recommends changing the administrator password in the system web interface.

1. Open a web browser and enter the system IP address.
When setting up your system, the onscreen instructions display the IP address to use.
2. Enter the username (the default is `admin`).
3. Enter the password (the default is the last six characters of your system's serial number).
The user name and password are case sensitive.

Navigating the Poly Studio G62 system interface

The conferencing provider that you choose determines the options for navigating the system.

After setting up your system, you can navigate the system using one of the following controllers:

In Poly Video mode and Poly Device Mode

- Poly TC10 or Poly TC8 touch controller
- Poly Bluetooth remote control
- Poly IR remote control

In Teams Rooms mode, Zoom Rooms, mode, Google Meet mode, and other provider modes:

- Poly TC10 or Poly TC8 touch controller
- Poly Bluetooth remote control
- Poly IR remote control

Using Device Mode

Connect a computer to the Poly Studio G62 system USB-C and HDMI input ports to use the Poly Studio G62 connected peripherals from your computer.

For more information on using Device Mode on your Poly Studio G62 system, see the *Poly Video Mode Administrator Guide* and the *Poly Partner Mode Administrator Guide* at <https://www.docs.poly.com>.

Updating your Poly Studio G62 system

You have several options to update your system software, depending on your environment.



NOTE: If you provision your system, the software update methods in the system web interface are unavailable. Configure the software update method using your chosen provisioning method.

1. In the system web interface, go to **General Settings > Device Management**.
2. Select one of the following options in the **Download Update From** field:

Software Update Method	Description
Poly Online Support Center	<p>A software server hosted by Poly.</p> <p>By default, your system is set to use the Poly update server for software updates. You can enable automatic updates or manually update your system using the system web interface.</p> <p>To use the Poly update server, make sure that your system can access <code>swupdate.lens.poly.com</code>. This URL is for system software access only. You can't access this server from a web browser.</p>

Software Update Method	Description
Custom Server URL	<p>Manually downloaded software from https://lens.poly.com/manage/software-versions.</p> <p>To ensure that the system recognizes the files and updates your system, retain the folder structure of the software downloaded from Poly Lens.</p> <p>A server on your network that supports HTTP or HTTPS downloads.</p> <p>The URL is the path to the latest software build folder (for example, <code>https://<system_build_folder></code>). It includes update packages for some of your connected devices (for example, a Poly TC10 device) and the video system.</p> <p>NOTE: If you are using private PKI certificates in your environment and want HTTPS software downloads to work, you must install the trusted root certificate from your internal certificate authority (CA) on the system since certificate validation is always performed.</p>
Microsoft Teams Device Management	For systems using the Microsoft Teams Rooms application. Selecting this disables other update controls on the page.
Provisioning Server	Receive updates from a provisioning service, such as Poly Clariti Manager.

3. If you download software from a **Custom Server URL**, enter the path to the software build folder on your network in the **Update Server Address** field.

Once you select from where to download software updates, you can manually or automatically update the system.

Updating Software in the System Web Interface

You can manually update software or set up automatic updates in the system web interface.

Automatically Update Software

Automatically update the software for your system and some of its paired devices.

1. In the system web interface, go to **General Settings > Device Management**.
2. Select **Enable Automatic Updates**.

Unless you specify a maintenance window, your system tries to update 1 minute after you enable this setting. If an update isn't available at the time, the system tries again every 4 hours.

3. **Optional:** Select **Only Check for Updates During Maintenance Hours** to specify a range of time to automatically update the software.
4. **Optional:** Choose times for **Maintenance Hours Begin** and **Maintenance Hours End**.

The system calculates a random time within the defined maintenance window to check for updates.



NOTE: If these settings are provisioned, the provisioning profile defines the polling interval. The default interval is 1 hour.

Manually Update Software

Manually update the software for your system and some of its paired devices.

1. In the system web interface, go to **General Settings > Device Management**.
2. Select **Check for Updates**.
3. If the system finds updates, select **Update All**.

Update your system using a USB flash drive

Update the software for your system and some of its paired devices using a USB flash drive.

If the system is asleep, wake the system by tapping the touch controller, touch screen, or using a connected remote control.



NOTE:

1. Log in to <http://lens.poly.com> and go to **Manage > Software Versions**.
If you don't have a Lens Cloud account, you can sign up for an account.
2. In the **Search Device Model / Lens App** drop down, type in the name of the device or search.
3. Select your device from the list.
The latest software version displays.
4. Select the software version you want to download and select **Download**.
5. Extract the files to a folder on your computer and move the content to the root directory of a USB flash drive and unzip the file.
The root directory of your USB flash drive should contain the file titled "softwareupdate.cfg" along with the individual folders for each product. The extracted files provide the required structure for the system to recognize the update package.
6. Connect the USB flash drive to a USB port on the back of the system.
When the system detects the USB flash drive, a prompt displays on the monitor to confirm that you want to update the software. If there's no input to the system, it automatically starts the update after a short delay.

Registering the System with Poly Lens

Poly Lens provides cloud-based management and insights for your system.

You can register your system with Poly Lens during system setup or on the Poly Lens registration page. For more information, see [Poly Lens Help](#).

Factory Restore the Poly Studio G62

When you factory restore the system, the system completely erases the flash memory and restores it to the factory restore partition software version.

See the *Poly VideoOS Release Notes*, Version History section, for the current factory restore version.

The system doesn't save the following data with a factory restore:

- Current software version
 - Logs
 - User-installed PKI certificates
 - Local directory entries
 - Call detail record (CDR)
1. To power off the system, disconnect the Ethernet cable from the PoE+ LAN port.
 2. On the side of the system, insert a straightened paper clip through the factory restore pinhole.

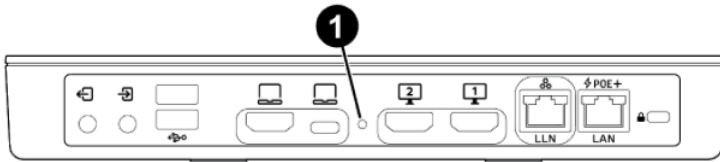

3. While pressing the factory restore pinhole button, power on the system by connecting the Ethernet cable to the PoE+ LAN port.
4. Continue pressing the factory pinhole reset button until the Poly Studio G62 LED flashes.

Locate the System IP Address Using the System Monitor and a USB Mouse

If you don't have a touch monitor, remote control, Poly TC8 or Poly TC10 touch controller paired to your system, you can use a USB mouse to identify the system IP address.

1. Connect a USB mouse to an available USB-A port on the back of the system.
A cursor appears.
2. Move the mouse to the right side of the screen.
3. Press the left mouse button and swipe left to reveal the Poly menu.
The IP address displays at the top of the menu.

Locate the System IP Address Using a Paired TC8 or TC10 Touch Controller

You can view the system IP address on a paired Poly TC10 or Poly TC8 touch controller.

1. On the Poly TC10 or Poly TC8 user interface, swipe left from the right side of the screen.
2. Select **Settings**.
System information, including the system IP address, displays.

Locate the System Serial Number

Use the system serial number to help technical support troubleshoot issues with your system.

The last 6-digits of the system serial number is the default system password.

- Do one of the following:
 - In the system web interface, go to **Dashboard > System Detail**.
 - On a paired Poly TC8 or Poly TC10 device, go to **Menu > Settings > Connected Room System**.
 - Locate the printed serial number on the bottom or rear of your system.
 - In Poly Lens, go to **Details > Device Information**.

Locate the Serial Number On Your Poly Studio G62

Where to find the serial number on the Poly Studio G62 device.

1. Find the serial number tag as shown in the illustration:

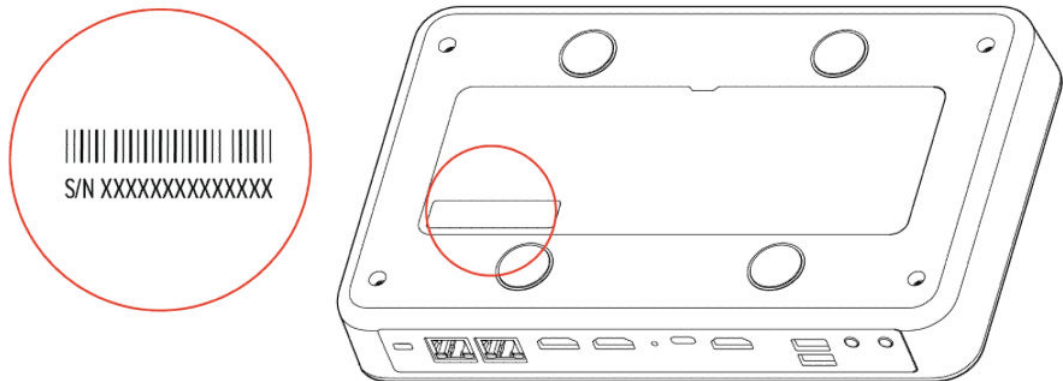

2. Write down the entire serial number (typically 14 characters), not the shorter number on the label.

6 Getting help

Poly is now a part of HP. The joining of Poly and HP paves the way for us to create the hybrid work experiences of the future. Information about Poly products has transitioned from the Poly Support site to the HP Support site.

The [Poly Documentation Library](#) is continuing to host the installation, configuration/administration, and user guides for Poly products in HTML and PDF format. In addition, the Poly Documentation Library provides Poly customers with information about the transition of Poly content from Poly Support to [HP Support](#).

The [HP Community](#) provides additional tips and solutions from other HP product users.

HP Inc. addresses

HP US

HP Inc.
1501 Page Mill Road
Palo Alto 94304, U.S.A.
650-857-1501

HP Germany

HP Deutschland GmbH
HP HQ-TRE
71025 Boeblingen, Germany

HP UK

HP Inc UK Ltd
Regulatory Enquiries, Earley West
300 Thames Valley Park Drive
Reading, RG6 1PT
United Kingdom

HP Spain

Cami de Can Graells 1-21
Bldg BCN01)
Sant Cugat del Valles
Spain, 08174
902 02 70 20

Document information

Model ID: PBJ-STG-62R (radio model) / PBJ-STG-62N (non-radio model)

Document part number: P03703-001

Last update: June 2024

Email us at documentation.feedback@hp.com with queries or suggestions related to this document.