

Polycom® RealPresence Trio™ 8800

See the Polycom RealPresence Trio 8800 Regulatory Notices guide for all regulatory and safety guidance prior to configuration.
 Avant de procéder à la configuration, veuillez consulter les Avis de réglementation du Polycom RealPresence Trio 8800, afin de prendre connaissance des recommandations en matière de sécurité et de réglementation.

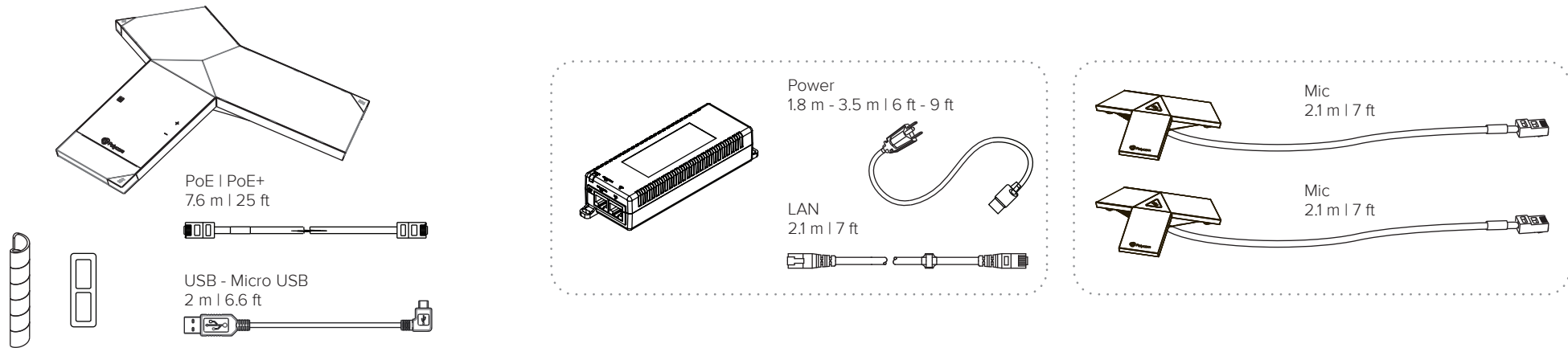

Minimum Setup

Installation des éléments de base
 Instalación necesaria
 Instalação básica

Grundinstallation
 Installazione necessaria
 Nødvendig oppsett

Minimális beállítások
 Konfiguracja minimalna
 Необходимая настройка

必須設定
 标准设置
 必要設定
 필수 설정

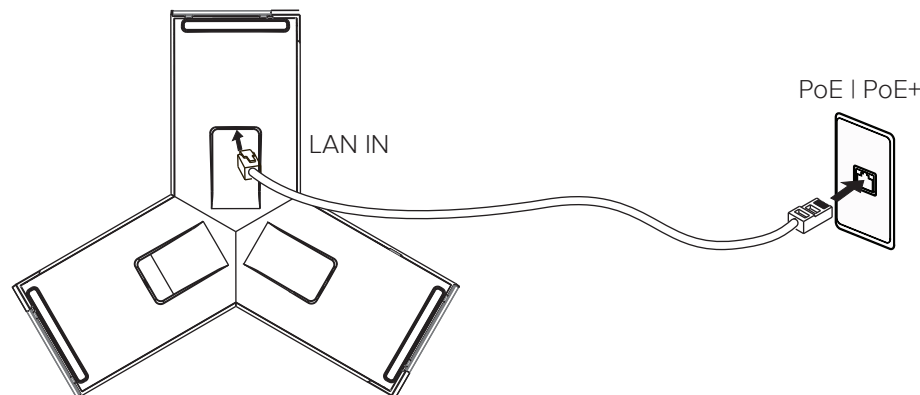

Optional Setup

Installation de l'équipement optionnel
 Instalación del equipo optativo
 Instalação do equipamento opcional

Einrichten der optionalen Ausrüstung
 Installazione delle apparecchiature opzionali
 Valgfritt oppsett

Kiegészítő beállítások
 Konfiguracija opcjonalna
 Дополнительная настройка

オプション設定
 选择设置
 選擇設定
 선택 설정

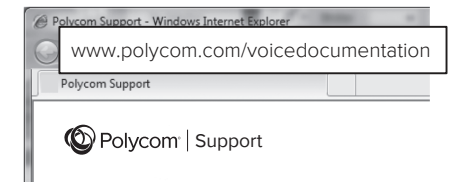
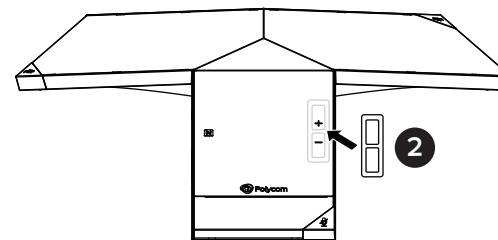
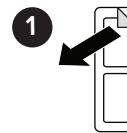
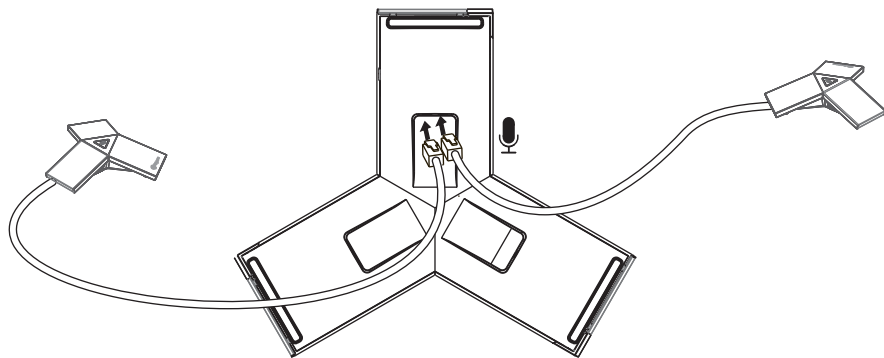
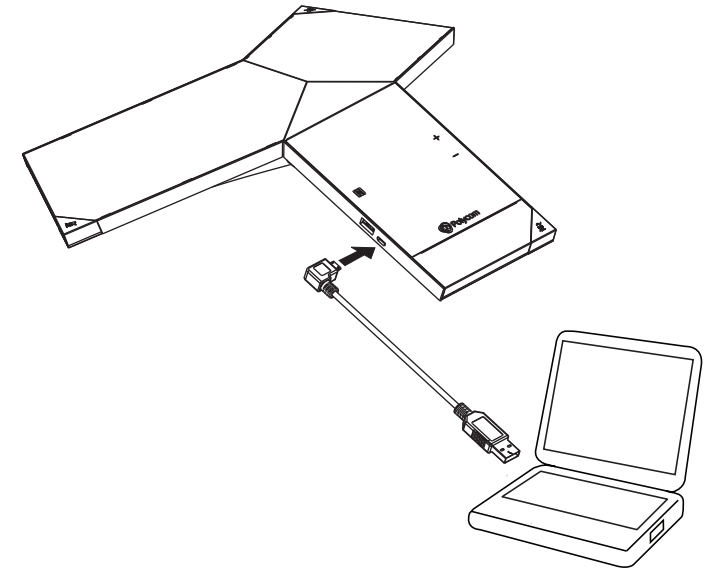
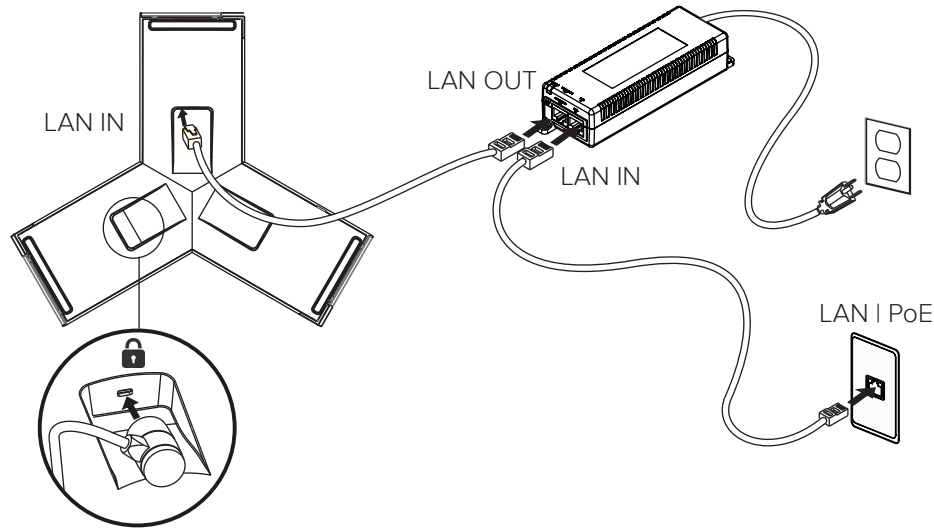

Product Documentation

- Documentation du produit
- Documentación del producto
- Documentação do produto
- Produktdokumentation
- Documentazione del prodotto
- Produktdokumentasjon
- Termékdokumentáció
- Dokumentacja produktu
- Документация продукта

Polycom Moscow
 T +7-495-924-25-25
 zakaz@polycom-moscow.ru
www.polycom-moscow.ru